



THE MODERN ENGINEER'S TOOLKIT

TABLE OF CONTENTS

01:

Page 3-6

HOW TO INNOVATE?
MYTHS ABOUT INNOVATION
THE SEVEN QUESTIONS THAT DRIVE INNOVATION
TIME FOR INNOVATION

02:

Pages 7 - 13

- *Get Some Good Data Measurement Software*
- *Automate More Design Tasks*
- *Use Software That Can Handle Different File Types*
- *Upgrade to More Efficient Hardware*
- *Upgrade to More Efficient CAD Software*
- *Change Your Approach to Design Documentation*
- *Update Your Approach to Complex Modeling*

03:

Pages 14 - 22

- WHAT COUNTS AS "INNOVATION"?
- *Use Modern CAD Software*
 - *Leverage an Integrated CAM Solution*
 - *Update Your Modeling Process*
 - *Improve Collaboration*
 - *Use Visualization*
 - *Use Simulation Throughout the Design Cycle*
 - *Try Generative Design and Topology Optimization*
 - *Use Prototyping*
 - *Use Additive Manufacturing*

04:

Page 23-26

THE FUTURE OF MAKING THINGS
CONCLUSION



OVERVIEW

OVERVIEW

HOW TO INNOVATE?

Today's engineers are under constant pressure to innovate as they search for better methods to design and make products that will have a significant impact.

Yet does anyone in your organization really know what it takes to be truly innovative? While stacks of books on innovation exist, very few offer practical advice on how to do it. In this eBook, we'll give you practical tips and strategies for unlocking innovation in your organization.



MYTHS ABOUT INNOVATION

There are a lot of misconceptions about what innovation really means.

MYTH #1 - "INNOVATION IS BIG."

The truth is that size doesn't matter. The real measuring stick is the impact innovation has on your team, your company, or the world.

MYTH #2 - "INNOVATION IS SOMETHING NEW."

Not always. An invention is new. Innovation can be new, but often it's a significant improvement or contribution to an existing product.

MYTH #3 - "WE NEED TO BE FIRST TO THE MARKET."

Not necessarily. A great example is Apple's iPod. It was late in the game for mp3 players. Their innovation was creating an easy-to-use ecosystem that helped revolutionize the music industry.

OVERVIEW

THE SEVEN QUESTIONS THAT DRIVE INNOVATION

Innovation isn't something that just happens by chance. On the contrary, the most successful innovations take a highly systematic approach and follow a very specific road map. To decide where to focus your efforts, ask yourself these questions:

- What could we **Look** at in a new way?
- What could we **Use** in a new way?
- What could we **Move**, changing its position in time or space?
- What could we **Interconnect** in a different way?
- What could we **Alter** or change about the design or performance?
- What could we **Make** that is truly new?
- What could we **Imagine** to create a better experience for someone?

Most often, an innovation is an improvement to an existing products as opposed to an entirely new product.

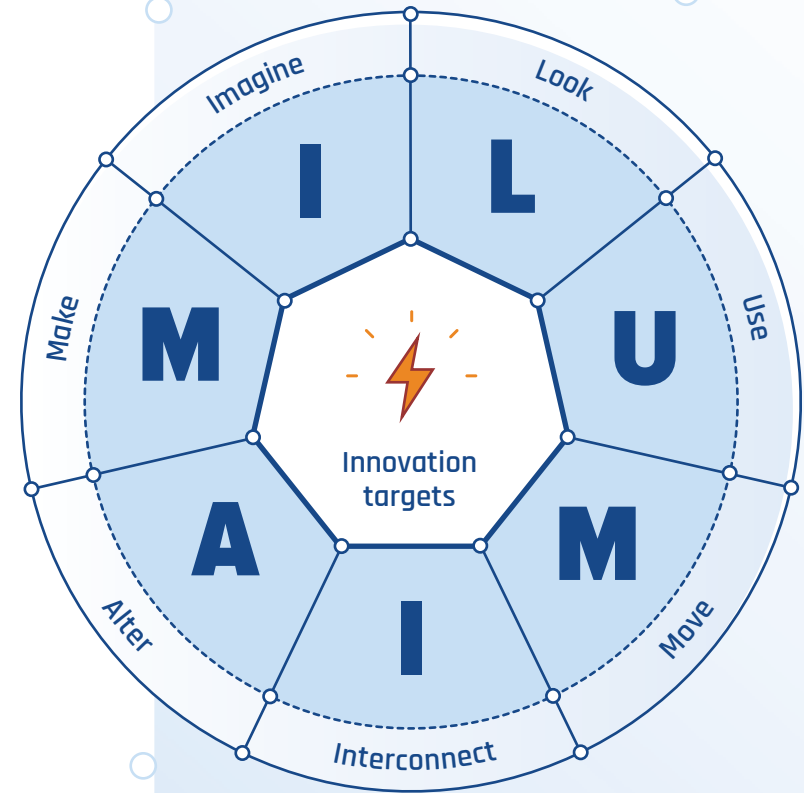

OVERVIEW

TIME FOR INNOVATION

Every engineer needs four resources to unlock innovation:

- Mindset
- Skill Set
- A Modern Engineer's Toolkit
- Time

For most organizations, the biggest barrier to innovation is time. It's critical to understand the tools you need to streamline your workflow so you can create the time needed to unlock innovation.

In the next chapter, we will examine numerous time-saving measures that can significantly impact multiple stages of your workflow. For example, we will dive into data measurement software, design task automation, design documentation and more.





SAVE TIME,
INNOVATE MORE

SAVE TIME, INNOVATE MORE

Get Some Good Data Measurement Software

As you know, the world of engineering contains thousands of files. What you may not realize is how much time your organization is wasting on managing them.

In this competitive environment, it's critical to have the right software to manage your intellectual property – the most important item your company produces.

How does data management software save time?

SEARCHING

On average, **engineers spend 15% of their day looking for files**. Eliminate searching through folders. Instead, type in anything you know about the file and let the system find it for you.

DESIGN REUSE

Reusing previously created designs can be a big time saver. But renaming files can be time consuming. Have a process in place for automated numbering schemes after the design has been copied to another project to save time.

APPROVALS

How do designs get approved in your organization? Does a piece of paper get placed on someone's desk? Most data management systems are paperless and automatically notify engineers to take action on a document. With this in place, you never need to take the time to leave your desk.

DUPLICATE FILES

It's not uncommon for multiple engineers to have the same file on their local hard drive. How do you know which one is the latest? With a data management system, it's impossible to open a file without a notification if it's out of date. And it updates the geometry for you. This system saves valuable time working on the wrong files.

SAVE TIME, INNOVATE MORE

Automate More Design Tasks

How much time do you spend on repetitive tasks in the design process? Chances are, there are ways to automate those tasks to save time. Here are some tips to help you save time.

FEATURES

As you model parts, you create features multiple times per day, every day. Imagine the time savings if you saved those features in a library. Even if there are several sizes and configurations, you only need one feature file. As the feature is used in new designs, the user is prompted to define the type and size.

PARTS

Some of the parts you use are similar to each other. Are you opening those files from other projects and making changes to them for the next design? If the answer is yes, then great! But why not take it a step further? Add those parts to a library and build some intelligence into them so they can be easily modified.

ASSEMBLIES

The intelligence you build into your component library will save time searching for parts, with the dimensions driven by selecting the desired configuration, rather than changing them manually.

TEMPLATES

Templates are another great way to accelerate the process of modeling parts. They not only contain all your preferred settings, they can also contain the first few features for commonly created models. This not only saves time, it also maintains consistency between similar components.

The bottom line? When you take just a small amount of time to set up an efficient system, you can save multiple hours over the period of a year – and every year after that.

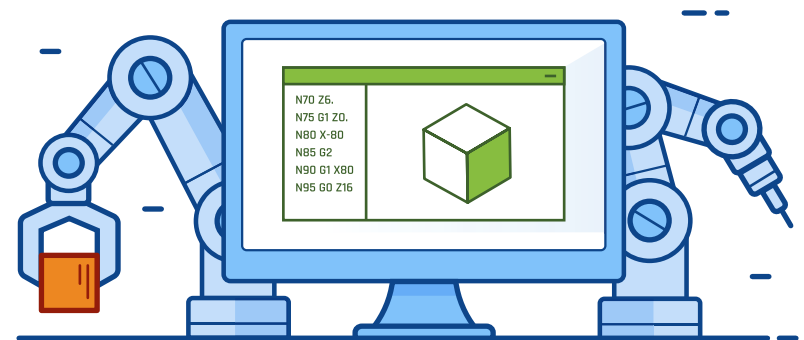

SAVE TIME, INNOVATE MORE

Use Software That Can Handle Different File Types

For most mechanical engineers, the process of working with multiple CAD systems is inevitable since engineering teams need to work with suppliers, and sometimes teams within the same organization will have different CAD systems. Traditionally, the process of reading non-native file formats can be painfully time consuming. First, the file needs to be translated and saved. Many times the geometry needs to be fixed or modified. Then a new version of the file is sent over from your customer, and the same time-consuming process starts over again.

If you are still importing and translating files from other CAD systems, you are wasting precious time and risking late deliverables.

Did you know there is software that can open files from other CAD systems and use those models in your assemblies? The models even update when changes are made from the native CAD application.

Once you stop spending hours a week translating and fighting with non-native CAD data every week, you'll have hours of time available for innovation.

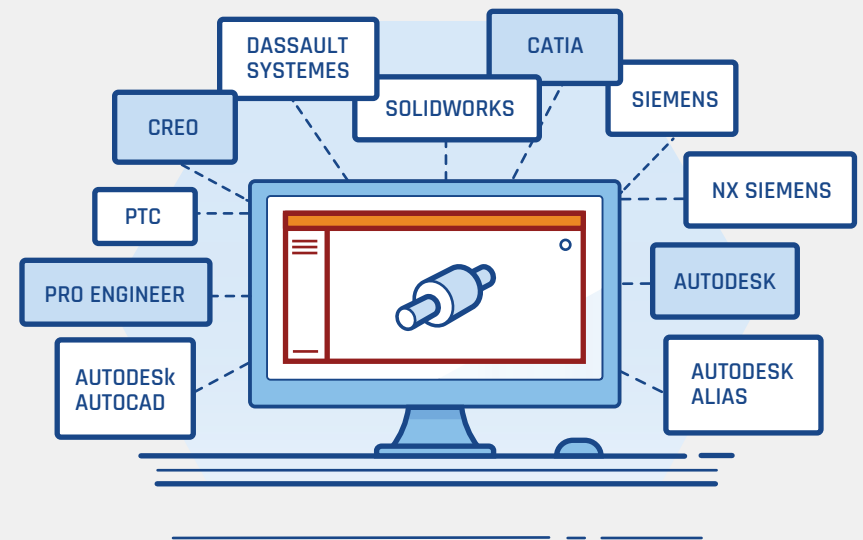

SAVE TIME, INNOVATE MORE

Upgrade to More Efficient Hardware

The software you choose is the foundation for improved efficiency. Updating your hardware is arguably the easiest and fastest path toward winning back time you can be using for innovation. Why? Over the past seven years, the increase in performance for processors and graphics processing units has increased exponentially. They are not merely double or triple the speed. We're talking about 50-100 times faster compared to 10 years ago!

Updating your hardware isn't only about saving time. It also gives you the ability to open large datasets and work with them in your design. This gives you a competitive edge. And if you can't open a large file on your CAD system, chances are there probably is someone else who can.

Update your hardware on a regular basis. On average, engineering departments replace their workstations every two to three years. A small time savings of two hours per month provides a considerable ROI for a new workstation every 3 years.

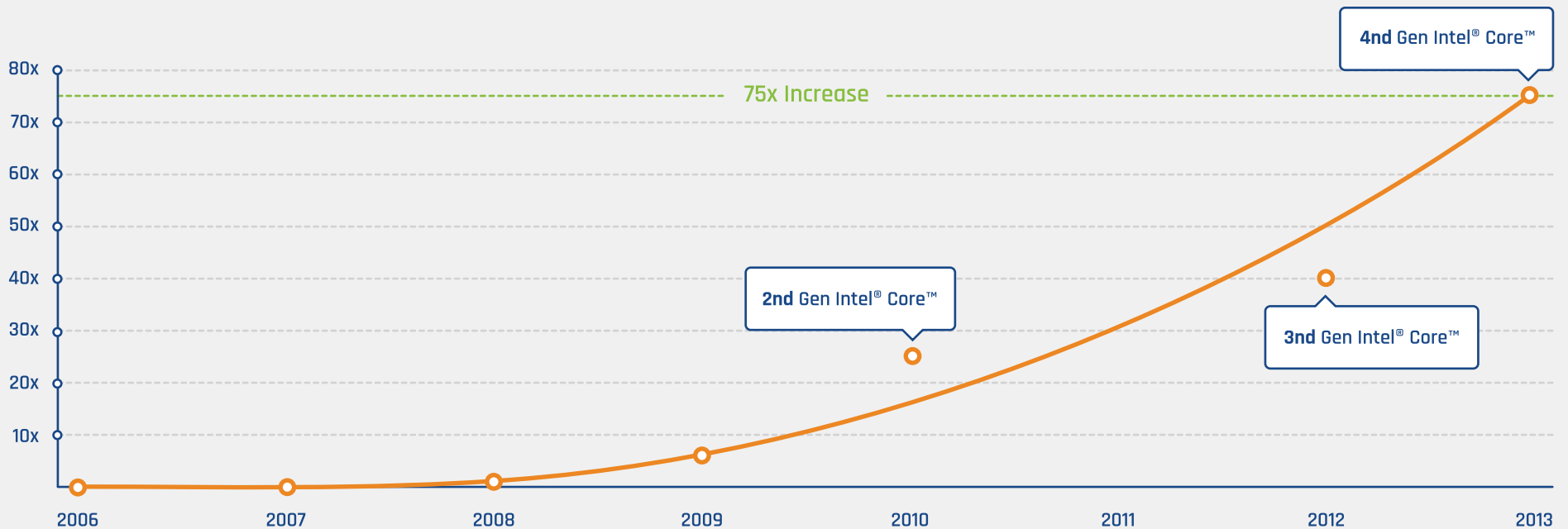

SAVE TIME, INNOVATE MORE

Upgrade to More Efficient CAD Software

If your toolkit is limiting the size and complexity of your product designs, this will have a significant impact on your ability to innovate. There have been tremendous improvements to CAD technology over the years, and consequently the modern CAD system is intelligent enough to recognize assemblies that will place a strain in the hardware. Because performance-based settings are automatically triggered, this optimizes the system to work faster, allowing engineers to spend less time attempting to understand and modify software preferences every time they open a large assembly or drawing.

That leads to yet another reason why engineering teams need to stay current with their CAD system. For every annual release, a development team focuses on improving performance in an effort to save time and create a better user experience.

Change Your Approach to Design Documentation

For decades, the manufacturing industry has relied on 2D drawings and struggled with interpretation and communication issues that go along with it. Although they're deep-rooted in most organizations, 2D drawings-based processes require human interpretation and are inevitably more time consuming and error-prone.

Currently, engineers spend a whopping 30% of their time creating documentation for manufacturing. The crucial question for engineers to ask is whether it's necessary to create a separate 2D drawing document for every single part.

Today's CAD systems provide the ability to apply all the manufacturing information you need directly to the 3D model. For some parts, it doesn't make sense to create views in a 2D drawing and dimension them. CNC software recognizes the features, geometry, and tolerancing, all within a single file. Today, drawings should only be done to support modern manufacturing methods – and the manufacturing method should determine whether one is needed.

SAVE TIME, INNOVATE MORE

Update Your Approach to Complex Modeling

To be able to truly innovate, you should have no limits to what you can model when you are designing the next generation of your product.

It used to be that creating and modifying complex model geometry was extremely difficult. Fast forward to today when the advancements in surface modeling have improved to the point where just about any shape can be created. And best of all, you no longer need an advanced level of knowledge.

Engineers now have the flexibility to work in a hybrid environment between feature-based parametric modeling as well as manually manipulate control points on a surface with a simple drag and drop. Stop spending hours of your day creating paths and guide curves for sweeps and lofts. They still have their place, but to truly innovate, feature-based modeling can limit your capacity.

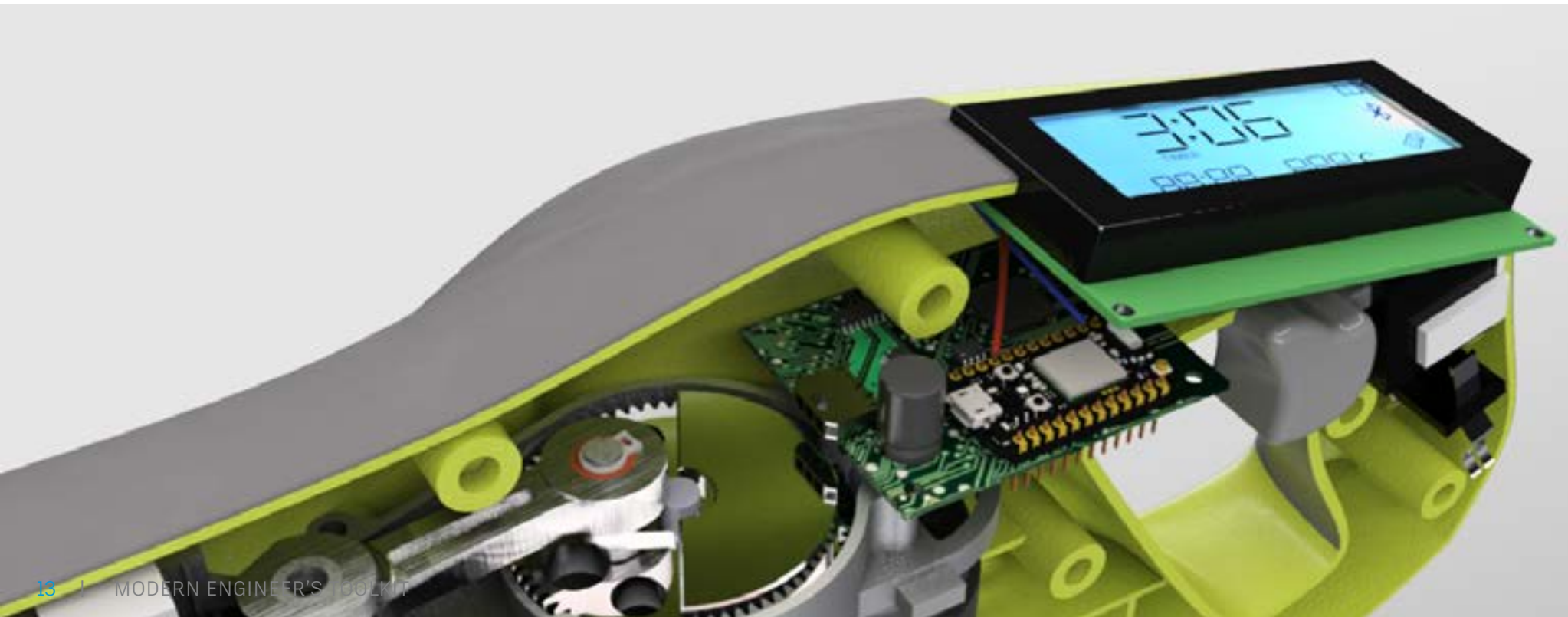



LEARN TO SPARK INNOVATION

LEARN TO SPARK INNOVATION

What Counts As “Innovation”?

Innovation isn't only about coming up with a brand new product. Often it involves improving a process or service for an existing product. In many cases, the greatest opportunity for innovation happens in the factory. Elon Musk put it best when he said: “The factory is the machine that builds the machine.”

Have you considered the fastest way to get the products you're designing out the door as soon as possible? Are you moving cardboard cutouts representing manufacturing equipment on a conference room table? Are you manually calculating time to volume? If so, you are not alone; but you're missing out on a critical opportunity to innovate your process, and ultimately your products.

Begin by creating the conditions that give rise to innovation. Consider these strategies:

USE MODERN CAD SOFTWARE

The great news is that the technology for laying out a factory floor can be done in popular CAD design software. This software allows you to test for bottlenecks, energy and travel costs, time to volume, bill of equipment, and clash detection between machines and building structures.

You can even plan for installation and commissioning. And all of this can be done without the need to learn another software interface.

LEVERAGE AN INTEGRATED CAM SOLUTION

The CAM system is no longer a tool exclusively for engineers working on the shop floor.

Integrating your CAM solution with your CAD design environment will provide critical opportunities for innovation. How? An integrated CAM system enables you to be more agile. Not only can you get the part from design to manufacturing faster, it also allows you to create a better design for manufacturing because they understand the process.

When engineers understand how products are made, they can find ways to minimize costs by reducing unnecessary complexities and reduce the setup and process time.

The importance of an integrated solution cannot be overstated: There is only one file. The GD&T from the model is repurposed for the machining strategy. This creates a seamless workflow from design to manufacturing without interruption. Together, these factors create an environment that is primed and ready to unlock innovation.

LEARN TO SPARK INNOVATION

UPDATE YOUR MODELING PROCESS

For years, engineers have been instructed, “Don’t mess up the feature tree.” And they often feel, “I can’t use this model because it has no feature history.”

In some cases, these statements are true. Traditionally, the behavior of the geometry in a feature-based model is dependent on the original design intent. Have you ever made a change to a part only to have it blow up on you? It happens to everyone using feature-based modeling techniques.

Does that mean it’s better to consider a direct modeling approach? Not necessarily. Rather, the answer is to use both. Take advantage of parametric feature-rich history trees along with the flexibility to directly edit the geometry. Avoid the cascading onslaught of red errors in the browser when changing the base feature in your part.

No feature history tree, no problem. Make changes directly to the geometry even if the model was created in another CAD system. Leverage direct modeling approaches to push, pull, and drag geometry. Your toolkit should have you covered in any modeling scenario.

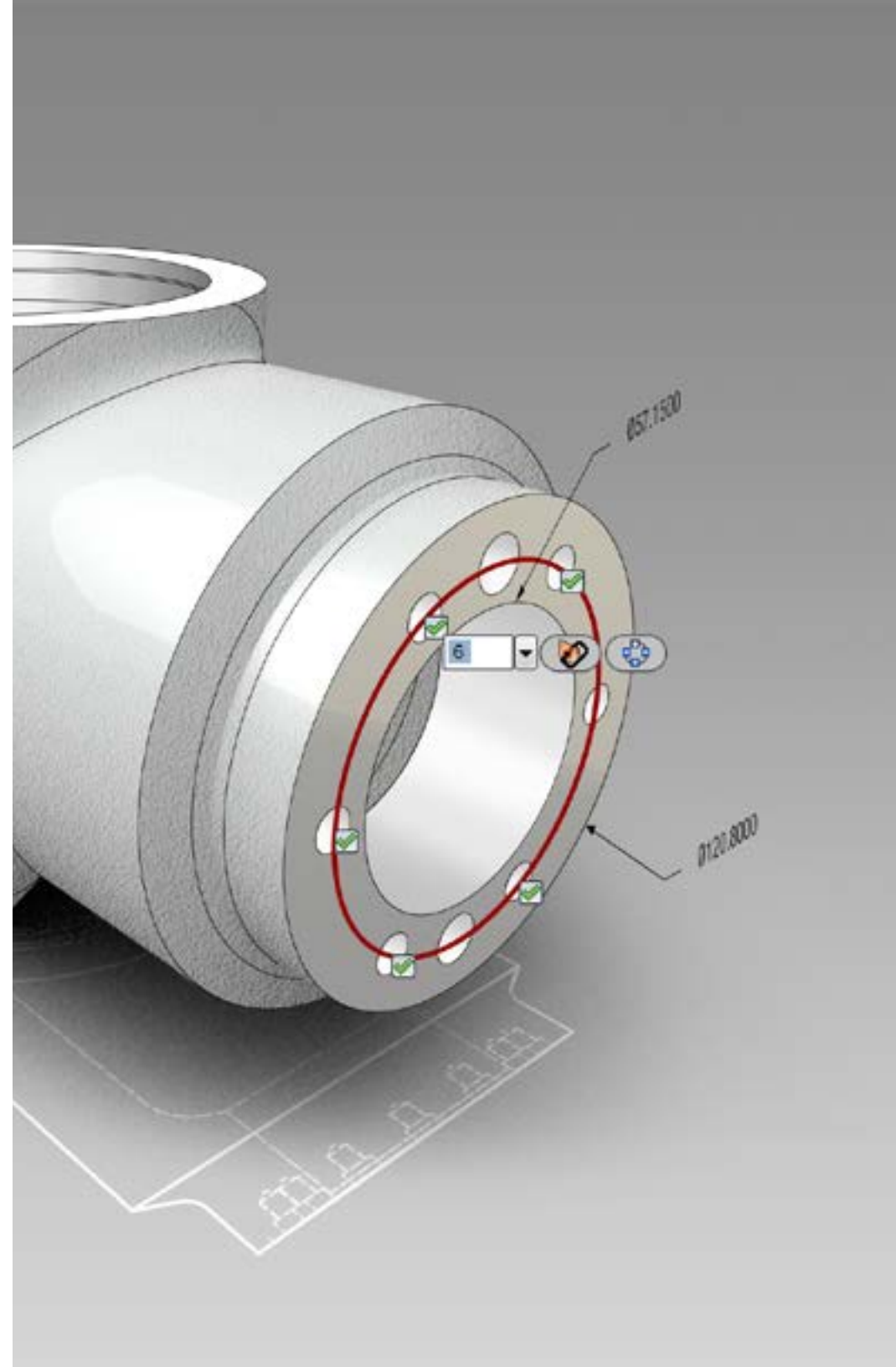

LEARN TO SPARK INNOVATION

IMPROVE COLLABORATION

As products are becoming increasingly complex, it's critical for modern engineers to no longer be single-disciplined.

For example, in the past, the electrical design was an afterthought once the mechanical portion was complete. Today, the addition of electronic components in your designs is becoming increasingly common. Engineers need to work with both the mechanical and electronic mechanisms in the design. The challenge is often to work on both concurrently.

To improve your capacity to innovate, your modern engineer toolkit should include bidirectional communication between mechanical and electrical designs. Any modification made to one affects the other in a shared seamless environment. If there are multiple engineers working on a project, this capability ensures both teams are working together to arrive at the best possible product design.

USE VISUALIZATION

Often innovation begins as an idea that is difficult to describe. Yet we all know it takes more than napkin sketches to work out the intricacies of a design and sell the idea to your boss or customer.

Visually compelling renderings are critical to innovation. They provide the inspiration and excitement needed to sell your idea or concept long before it exists in the physical form. And today, the ability to create photorealistic images of a concept is easier than ever. Sometimes, these capabilities are built right in the CAD design environment. The tools for applying proper material and texture mapping are integrated into the material library.

It's also important to take advantage of the unlimited computing power in the cloud. Renderings can require precious computing power that you need for other engineering tasks.

LEARN TO SPARK INNOVATION

USE SIMULATION THROUGHOUT THE DESIGN CYCLE

Simulation is a critical tool for innovation at every stage of the design cycle, as it is key to driving design improvements and exploration. Simulation comes in several forms, from hand calculations and hand drawn diagrams to virtual testing and physical prototypes.

Since the time and cost for making design changes increases towards the end of a product development process, testing your products with simulation should begin early -- during the concept and design phase. Starting to test early will give you the opportunity to experiment more broadly with the possibilities for making innovative improvements. Changes at these earlier stages can be made quickly and easily.

At these earlier stages, simulation can also serve as more than just a tool for validating design ideas; it can help you explore and discover new ways to design and manufacture your products. With the right tools, simulation can even suggest ways to design the product that you haven't imagined.



Traditional Design Process



Concurrent Design Process

LEARN TO SPARK INNOVATION

TRY GENERATIVE DESIGN AND TOPOLOGY OPTIMIZATION

Over the years, the design tools we use to make products have become easier than ever to use. While those tools have advanced the way we design, they have also defined our aesthetic and limited our imaginations. What if instead of drawing what you already know, you could tell the computer what you want to accomplish?

This is now possible. Instead of drawing the product and modifying the form, you can now tell the computer how much it needs to support, how much it should weigh, how much it should cost, and the desired material. The computer can then deliver thousands – if not millions – of design options, all of which meet your criteria. From those options, you can then pick the one design that delivers on the most important criteria. The selected design often is one that the designer would have never imagined. That is the promise of generative design.

The benefits of generative design are potentially staggering, including unprecedented reductions in costs, development time, and material consumption. With topology optimization, the sky is the limit.

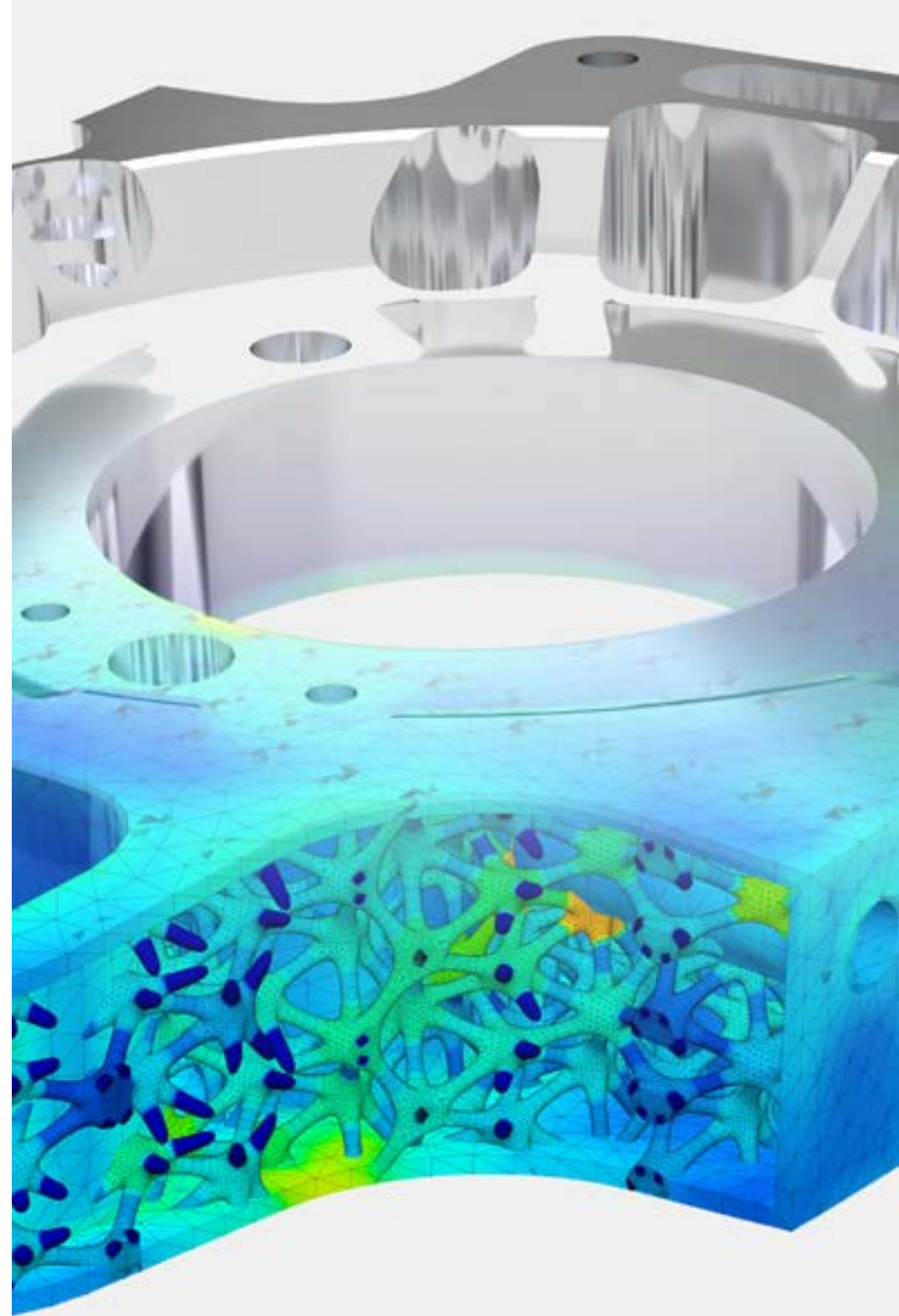

LEARN TO SPARK INNOVATION

USE PROTOTYPING

No matter how much virtual testing you do, you still need to create a physical prototype to test the fit, form, and function of your design. Yet the process of making a prototype can be potentially costly and time consuming. 3D printing can make prototyping more efficient for several reasons:

- **Material**

There are now dozens of materials to choose from between metal and plastic

- **Predictable**

The build time for additive manufacturing is often well known, enabling engineers to achieve a production schedule that is more precise

- **Outsourcing**

If you don't own a 3D printer, there are several companies that will print it for you and ship it right to your door.

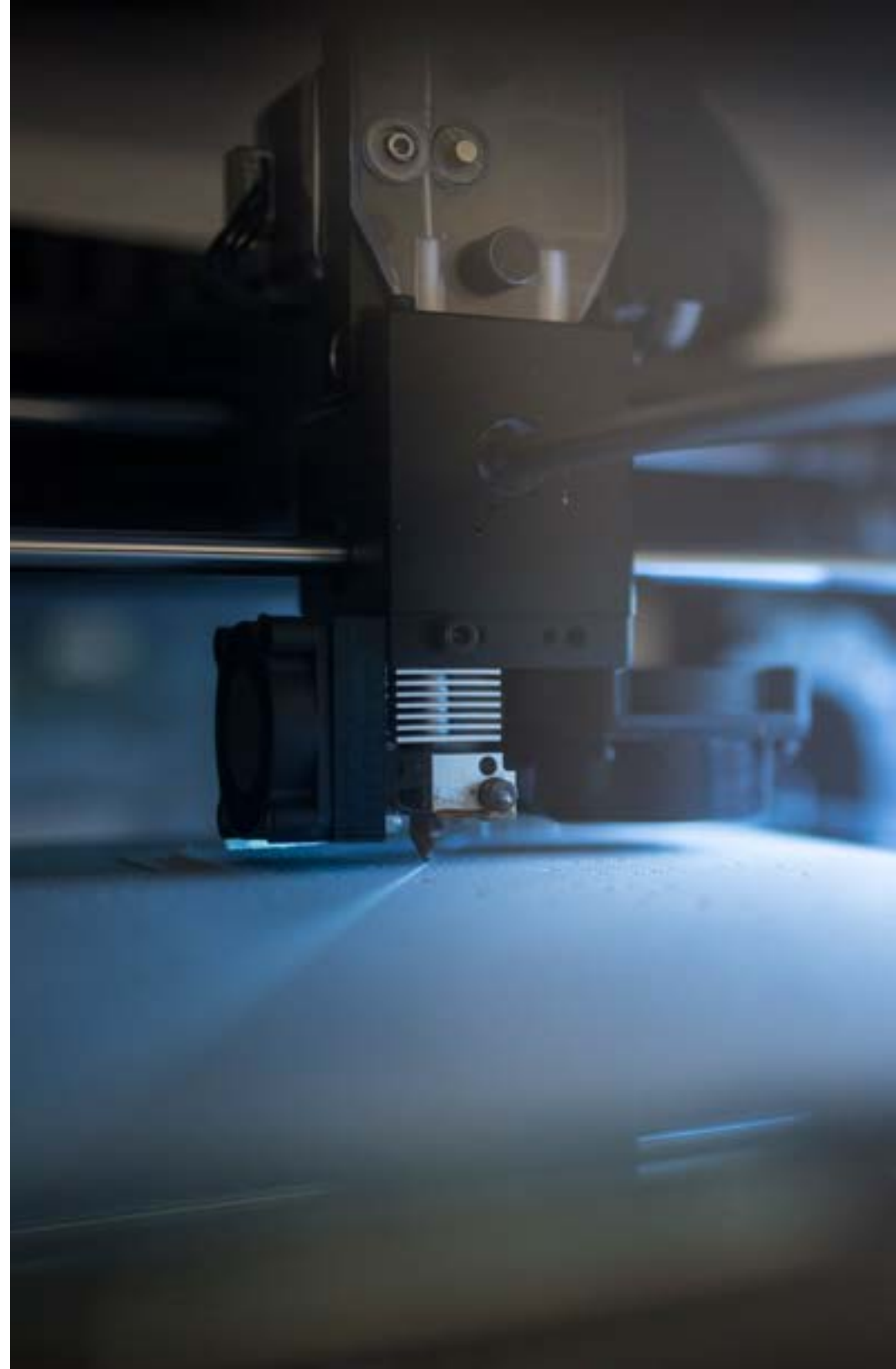

LEARN TO SPARK INNOVATION

USE ADDITIVE MANUFACTURING

Innovation extends beyond the product design, and into the way it is made. Additive manufacturing – the industrial version of 3D printing – is a great option for highly complex, low volume components.

Additive manufacturing enables you to design innovative products without the limitation of traditional manufacturing methods. The benefits are clear: Forms can be created that would be impossible to make on a CNC machine. The setup time for the additive process is significantly less compared to programming the machine and preparing the tooling for cutting a block of metal.

What if instead of making an assembly, you could create a single part? Imagine the time you could save if you could eliminate assembly processes like fasteners, welding, or brazing. Additive manufacturing is not meant to replace all existing machining processes, but it has the potential to extend the capabilities of production.

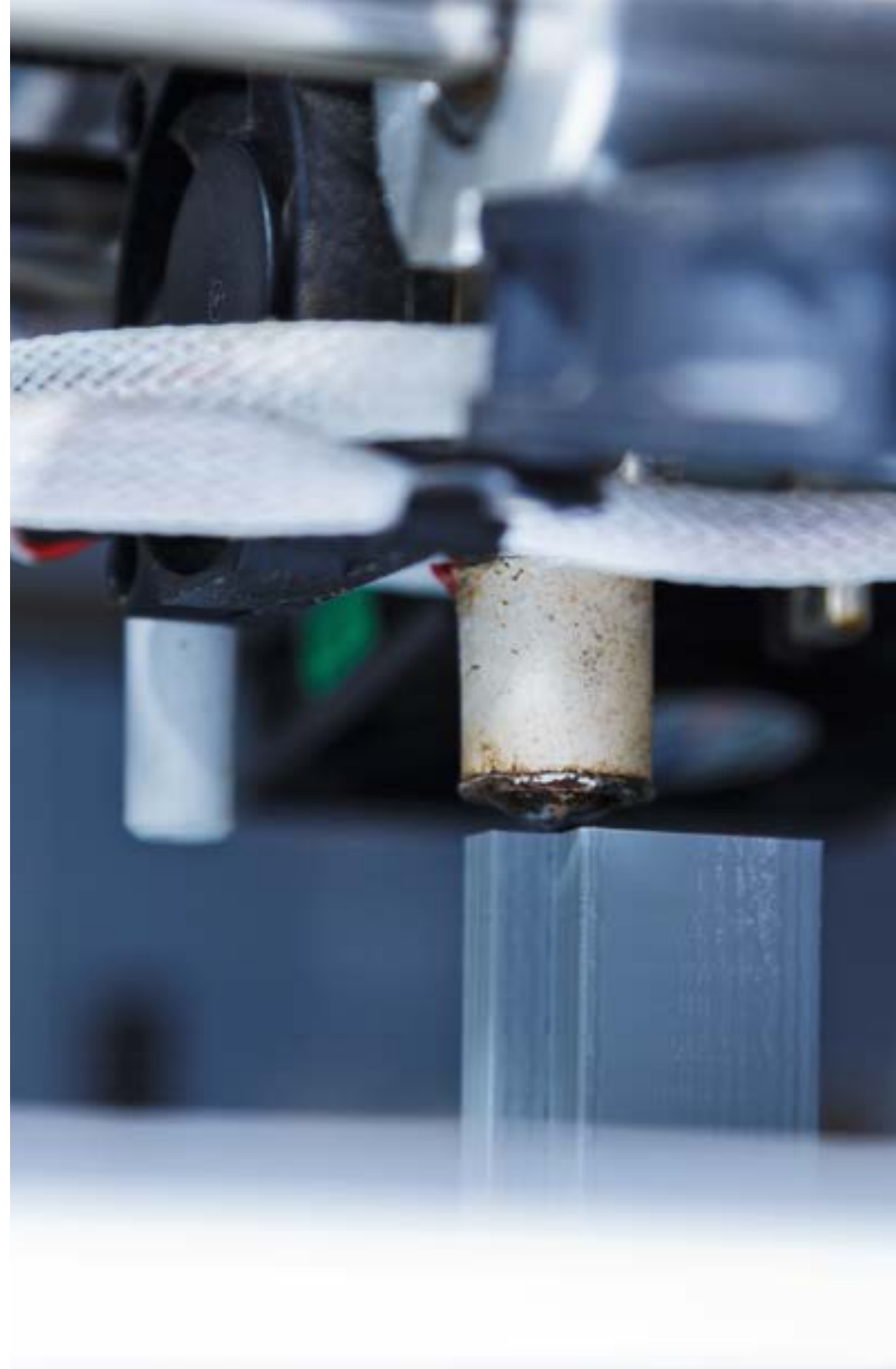



FINAL THOUGHTS

FINAL THOUGHTS

The Future of Making Things

There have been radical changes in the way products are designed, made, and used. This disruption has created an opportunity for modern mechanical engineers. The right toolkit gives you the ability to innovate more quickly. In addition, companies can meet consumer demands for customized products and get the product out the door faster. The understanding of how products are used boosts customer satisfaction and facilitates the next version of the design. Here's how these changes have altered the landscape:

DESIGN

Designers are now collaborating on a global scale for a higher level of skillsets and expertise. They have access to vast amounts of data and computing power available anytime, anywhere thanks to the cloud.

MAKE

Advanced manufacturing methods are hastening the speed to market. Microfactories are replacing traditional production facilities, enabling startups to compete with large corporations.

USE

Digital systems are being integrated with physical objects, making them connected and intelligent. Data can then be collected and used to provide insight for future improvements to products.



FINAL THOUGHTS

Conclusion

Push the boundaries of what is feasible to unlock innovation for your organization. With the proper toolkit, your capacity to design and make innovative products is at your fingertips.

With the right toolkit, you can:

- Save time—so there's more available for innovation
- Learn to spark innovation

Get Started

Read to explore software solutions that can help boost productivity? Check out product demo videos to learn about how various software solutions can help you become a best-in-class job shop.

[EXPLORE SOFTWARE SOLUTIONS >](#)



Autodesk and the Autodesk logo are registered trademarks or trademarks of Autodesk, Inc., and/or its subsidiaries and/or affiliates in the USA and/or other countries. All other brand names, product names, or trademarks belong to their respective holders. Autodesk reserves the right to alter product offerings and specifications at any time without notice, and is not responsible for typographical or graphical errors that may appear in this document.

© 2017 Autodesk, Inc. All rights reserved.