

AutoCAD 2015 productivity study

A comparison of AutoCAD 2010 and AutoCAD 2015 running on Dell Precision T1600 and T1700 workstations

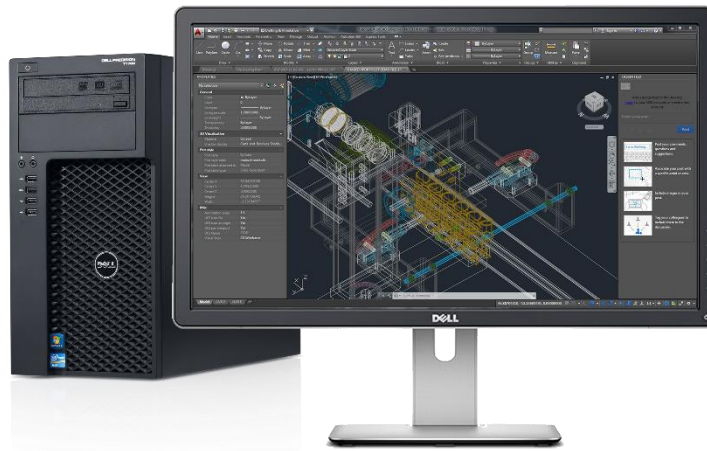

Commissioned by



By
David Cohn



June 20, 2014

The performance results and statistical information reported in this paper were derived from tests commissioned by Autodesk and Dell and conducted over a controlled network using Autodesk® AutoCAD® 2010 software, Autodesk® AutoCAD® 2015 software, a Dell Precision™ T1700 Mini Tower Workstation, and a Dell Precision™ T1600 Mini Tower Workstation performed selected tasks designed to simulate day-to-day production tasks. As with all performance tests, results may vary based on machine, operating system, filters, and even source material. While every effort has been made to make the tests as fair and objective as possible, your results may differ. Product information and specifications are subject to change without notice. Autodesk provides this information “as is,” without warranty of any kind, either express or implied.

AutoCAD 2015 productivity study: A comparison of AutoCAD 2010 and AutoCAD 2015 running on Dell Precision T1600 and T1700 workstations

By David S. Cohn

Executive summary

The performance of a computer system is often measured using standard benchmarks. But actual user productivity is a much more difficult metric to gauge, since it often includes perceptions of the overall user experience and must account for differences in the methods employed while using the software.

In order to quantify the potential productivity improvement a typical user is likely to experience when upgrading to the latest version of Autodesk® AutoCAD® software as well as upgrading to a more modern workstation, I devised a series of tests involving timing the repeated re-creation of a selection of drawings using both AutoCAD 2010 and AutoCAD 2015 software. The drawings used were judged to be representative of those that would be produced by typical AutoCAD users.

I performed the tests utilizing the features and functions I judged to be the most expedient means of producing the end result in each respective version of the software.

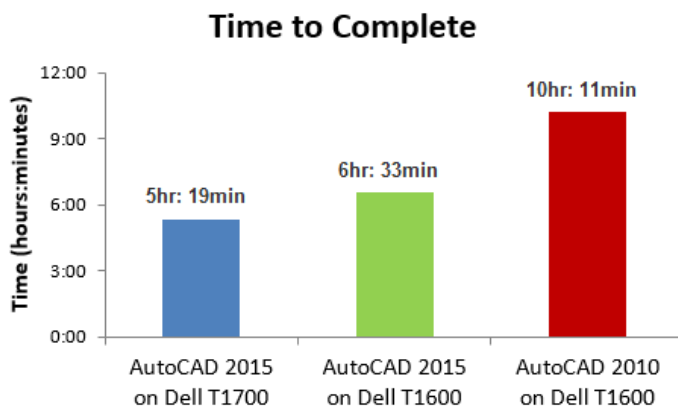

The results of the study were dramatic. It took more than 10 hours to complete the five drawings using AutoCAD 2010 compared to 6.5 hours to complete the same five drawings using AutoCAD 2015. This represents time savings of 36 percent as a result of upgrading from AutoCAD 2010 to AutoCAD 2015, without any change in the computer on which AutoCAD was run. When the workstation was also upgraded to a more modern system, the time required to complete the five drawings using AutoCAD 2015 was further reduced to 5.3 hours, a total time savings of 48 percent compared to using AutoCAD 2010 on an older workstation.

Upgrading the workstation as well as upgrading from AutoCAD 2010 to AutoCAD 2015 resulted in an average overall productivity improvement of more than 90 percent.

Although the actual productivity improvements likely to be achieved by a specific individual will vary based on the user's level of experience and the nature of the drawings being produced, I feel that similar improvements in personal productivity are likely, thanks to the new features and functions available in AutoCAD 2015, compared to AutoCAD 2010. The level of improvement in personal productivity is so significant that most users will find that it easily justifies the cost of upgrading their version of AutoCAD as well as purchasing an up-to-date workstation.

Do new features result in increased productivity?

AutoCAD was first released in December 1982. Each release since then has offered numerous new features and functions that have contributed to improve the overall productivity and usefulness of the software beyond each previous release.

One could argue that by upgrading to the latest release, customers would actually save money because the features and functions of the new software would enable them to complete their work faster than would be possible had they used an earlier version of the software. Yet many customers skip releases for economic reasons.

Improvements in computer hardware technologies also continue at a rapid pace. The raw performance of today's Intel-based engineering workstations is more than 500 times faster than a typical personal computer used to run AutoCAD in 1982, on pace with Moore's law. Improvements in graphics processing outpace Moore's law, delivering ever-increasing power at more affordable price points.

The question becomes one of quantifying the actual productivity improvements a user could reasonably expect to achieve by upgrading from their old version of AutoCAD to the latest release while also upgrading their workstation to a more modern system featuring a more advanced CPU and graphics accelerator.

Developing the study criteria

In the spring of 2014, Autodesk approached me to conduct a productivity study comparing AutoCAD 2010 to AutoCAD 2015. The study involved a selection of five drawing tasks designed to replicate how real AutoCAD users operate so as to reflect a realistic expectation of user productivity. The drawings used were typical of those produced by actual AutoCAD customers. The test required manually re-creating these drawings multiple times using both AutoCAD 2010 and AutoCAD 2015. These re-creations would utilize features and functions judged to be the most expedient method for producing the desired end results. The time required to create each drawing would be recorded using a stop watch and rounded to the nearest minute. The drawings would be created using AutoCAD 2010 on an engineering workstation equipped with a discrete graphics accelerator card typical of those in use in 2010. The same drawings would also be created using AutoCAD 2015 on the same workstation, as well as AutoCAD 2015 on a newer engineering workstation equipped with a newer graphics processing unit (GPU).

After considering dozens of drawings produced by actual AutoCAD users, I selected five drawings that I judged would require a typical user anywhere from an hour to half a day to complete.

Each drawing was chosen based on a number of criteria designed to showcase one or more features of the software that did not exist in AutoCAD 2010 but were added in subsequent releases. While each drawing could certainly be produced using the features and functions available in AutoCAD 2010, the advanced capabilities added in subsequent releases would likely enable a typical user to produce the drawing faster using AutoCAD 2015.

Since the premise of the test was to determine how much time could be saved by using a new feature, the test itself was already predisposed to show that using AutoCAD 2015 is more productive than using AutoCAD 2010. However, since each of the drawings used in the study was originally produced using versions of AutoCAD predating the 2010 release, I concluded that the study would present a realistic analysis of the productivity gains a typical user could achieve.

In order to eliminate additional biases in the design of the study, such as improvements in speed simply due to increasing familiarity with the sample drawings, some of the sample drawings were produced first using the 2015 release of the software and then produced using AutoCAD 2010, tilting any such improvements in the favor of the older release. Each drawing was also reproduced in each release several times and only the fastest times were ultimately included in the results.

In spite of focusing on new features, I expected to see only modest reductions in the time required to produce the drawings in the newer release. I did not expect to see dramatic improvements in overall user productivity. Most CAD drawings consist of lines, arcs, and circles, and I reasoned that there have been very few changes that would improve the speed at which a typical user would be able to create or modify the objects that represent the majority of a typical drawing. After all, how much faster can you draw a line?

Dramatic results

The results of the study were more dramatic than I expected. It took 10 hours: 11 minutes to complete all five drawings using AutoCAD 2010, compared to 6 hours: 33 minutes to complete the same tasks using AutoCAD 2015 on the same Dell Precision T1600 workstation, a time savings of 36 percent for tasks representative of the types of drawings typically created and edited using AutoCAD. When these same drawings were created again using AutoCAD 2015 on a more modern computer, a similar but newer Dell Precision T1700 workstation, it took just 5 hours: 19 minutes to complete all five drawings, a total time savings of 48 percent compared to AutoCAD 2010. On individual tasks that focused on specific aspects of the software, the time required to produce the drawings went down anywhere from 29 to 67 percent.

The following chart illustrates the cumulative improvement in overall productivity, represented as the total time required to complete the five sample drawings in AutoCAD 2015 compared to AutoCAD 2010.

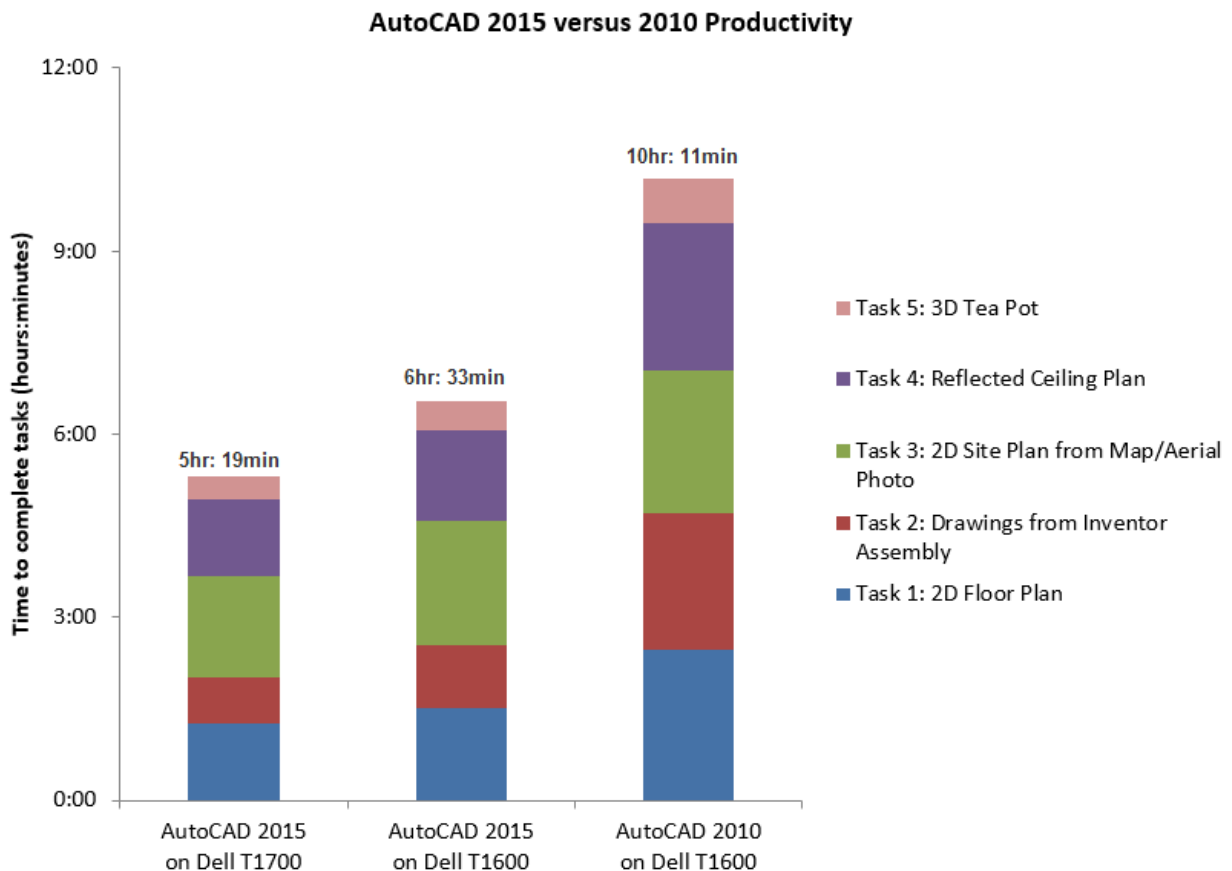

Time to complete all five drawing tasks in AutoCAD 2015 versus AutoCAD 2010.

The study in detail

The AutoCAD 2015 productivity study compared the time required to produce a collection of five different drawings multiple times using both AutoCAD 2010 and AutoCAD 2015, using the features and functions judged to be the most expedient method for producing the desired end result. The time required to create each drawing was recorded using a stop watch and rounded to the nearest minute. Results were recorded for three different scenarios:

- AutoCAD 2010 run on a Dell Precision™ T1600 workstation equipped with an NVIDIA® Quadro® 2000 graphics accelerator, running Windows® 7
- AutoCAD 2015 run on the same Dell Precision T1600 workstation running Windows 7
- AutoCAD 2015 run on a Dell Precision T1700 Mini Tower workstation equipped with an NVIDIA Quadro K2000 graphics accelerator, running Windows 7

Each drawing task required many common AutoCAD commands. But each was selected because certain aspects of the drawing would expose the potential time savings that could be achieved by using features and functions not available in AutoCAD 2010 but added to subsequent releases and therefore available to someone using AutoCAD 2015.

Drawing task #1

The first drawing represents a typical two-dimensional drawing that might be produced using AutoCAD—a floor plan of a medical clinic. In addition to having to draw walls, doors, and windows on their appropriate layers, this drawing also requires the creation of numerous blocks to represent furniture and plumbing fixtures and the subsequent insertion of those blocks at the proper locations in the drawing. Figure 1 shows the completed task #1 drawing.

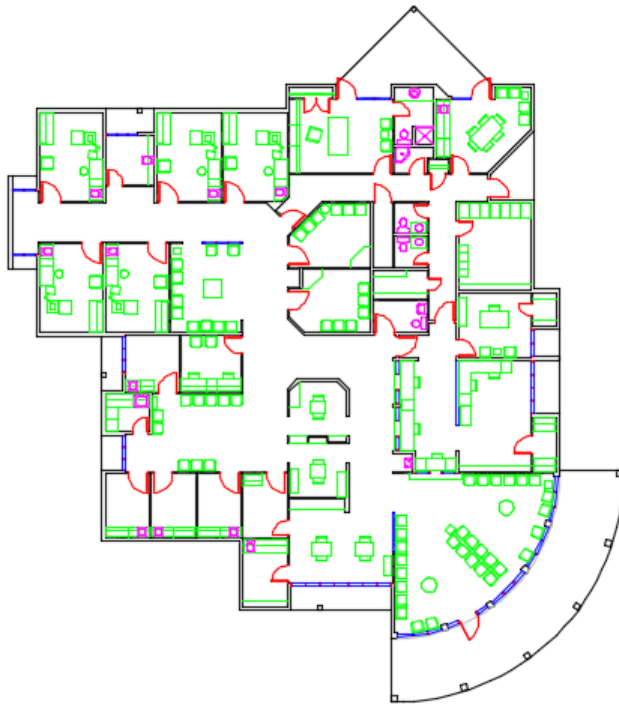
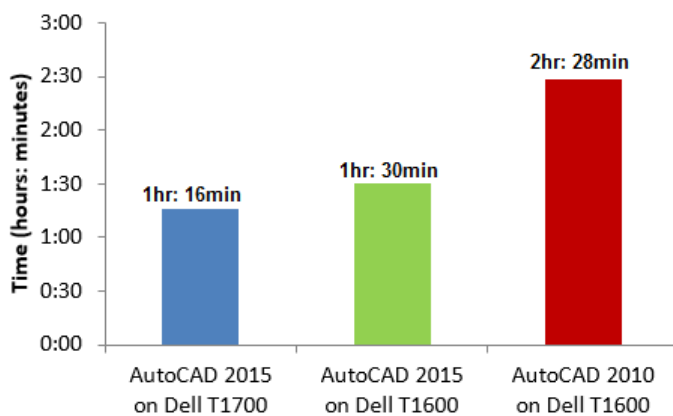

Figure 1: Task #1 completed two-dimensional floor plan of a medical clinic.

In comparing AutoCAD 2010 to AutoCAD 2015, I had anticipated productivity improvements in a number of areas:

- The insertion of blocks would be faster in AutoCAD 2015 as a result of being able to use galleries instead of the block insertion dialog box.
- Associative arrays could be used in AutoCAD 2015 to create some furniture layouts versus non-associative arrays in AutoCAD 2010.
- Groups could be used to duplicate repetitive collections of furniture layouts.
- The Select Similar tool could be used to speed object creation in AutoCAD 2015.

This drawing took 2 hours: 28 minutes to complete using AutoCAD 2010 on the Dell Precision T1600 workstation. The same drawing took only 1 hour: 30 minutes to complete using AutoCAD 2015 on the same workstation, a time reduction of 39 percent. When the same drawing was created using AutoCAD 2015 on the Dell Precision T1700 workstation, the time required went down an additional 14 minutes, or 16 percent.



Task #1: 2D floor plan.

AutoCAD 2015 was more efficient in the creation of the task #1 drawing than AutoCAD 2010, largely thanks to the improved block insertion capabilities afforded by the new gallery feature in AutoCAD 2015. Associative arrays and improved group capabilities also proved quite helpful.

When the improvement due to the upgraded workstation was factored in, the overall time required to complete this task improved by a total of 49 percent from AutoCAD 2010, thanks largely to improved graphics performance.

Drawing task #2

The second drawing task was the recreation of several sheets of two-dimensional drawings of a three-dimensional mechanical assembly model of an arbor press that had originally been created using Autodesk® Inventor® software. This model was not actually created in AutoCAD, but rather exploited the ability to import an Inventor model.

Since AutoCAD 2010 does not have the ability to import files directly from Inventor, the arbor press model was first opened in Autodesk Inventor and saved as an SAT file. That file was then imported into a new AutoCAD 2010 drawing. Since Inventor files can be imported directly into AutoCAD 2015, this intermediate step was not required. The Inventor assembly file was therefore imported directly into a new AutoCAD 2015 drawing.

In both versions, once the 3D model had been imported into model space, three separate layouts were created. A custom border and title block was created and saved as a block, with appropriate attributes to fill in the title block with data such as scale, part number, and sheet number. This title block was inserted onto each layout, and then appropriate views were created for each of the seven major components. The first layout showed an isometric

view and orthographic views of the completed assembly with each part labeled, as well as a bill of materials showing the part number, quantity, part name, description, and material. The other two layouts showed 2D orthographic views of individual parts at appropriate scales, complete with dimensions. Several parts also included section and detail views. Two of these sheets are shown in Figure 2.

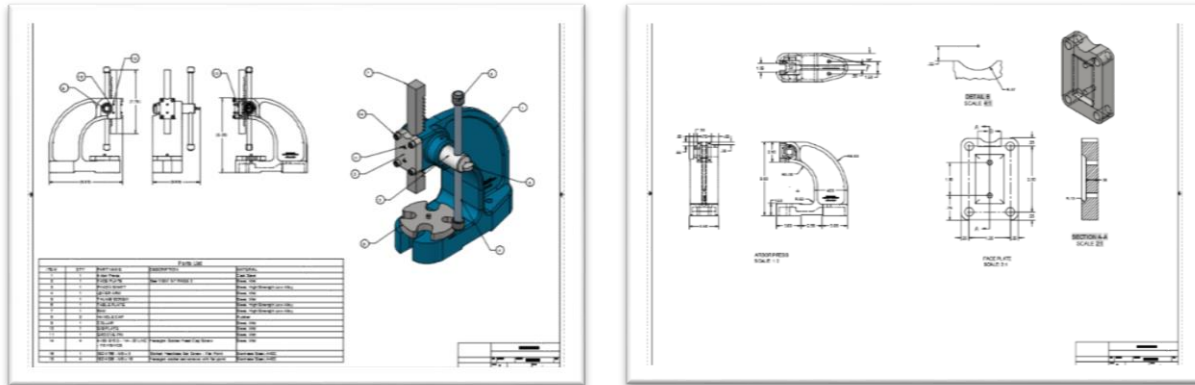
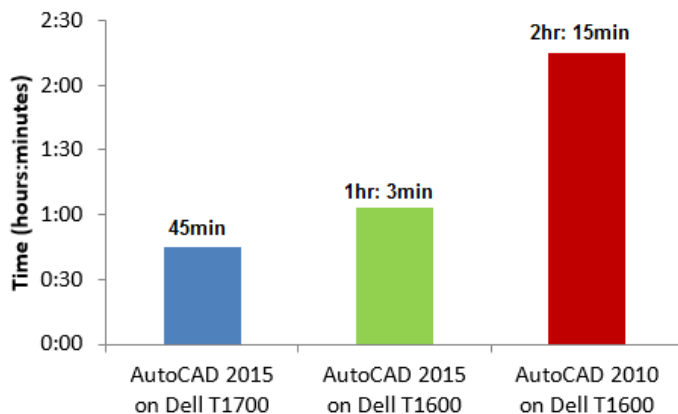

Figure 2: Completed task #2 drawing—a 3D mechanical assembly with separate sheets for individual parts.

Thanks to the improved functionality in AutoCAD 2015 compared to AutoCAD 2010, I anticipated productivity improvements in a number of areas:

- The task of initially importing the Inventor assembly model into a new drawing would be faster and easier in AutoCAD 2015 since the Inventor file could be imported directly, whereas in AutoCAD 2010, the file had to first be exported to an intermediate format before it could be imported into a new drawing.
- The drawing views features in AutoCAD 2015 would make it much easier to create the orthographic, section and detail views compared to having to use section planes and the Flatshot tool in AutoCAD 2010.

This drawing took 2 hours: 15 minutes to complete using AutoCAD 2010 on the Dell Precision T1600 workstation. The same drawing took only 1 hour: 3 minutes to complete using AutoCAD 2015 on the same workstation, a time reduction of 53 percent. When the same drawing was created using AutoCAD 2015 on the Dell Precision T1700 workstation, the time required went down an additional 18 minutes or 29 percent.



Task #2: Drawings from an Inventor 3D mechanical assembly.

While all of my assumptions proved true, the time required to import the SAT file into AutoCAD 2010 was not significantly different from the time required to import the native Inventor assembly into AutoCAD 2015. Once the

model had been imported, however, the time required to produce the two-dimensional layouts was significantly shortened in AutoCAD 2015 thanks to the ability to create drawing views. In addition, had any changes been made to the 3D model, those changes could have been reflected almost immediately in the orthographic drawing views in AutoCAD 2015, whereas in AutoCAD 2010, each orthographic view would have to have been updated individually by recreating the flatshot view or updating the block generated using the Section Plane tool.

When the improvement due to the upgraded workstation was factored in, the overall time required to complete this task improved by a total of 67 percent from AutoCAD 2010, again largely due to significant improvements in graphic performance.

Drawing task #3

The third drawing task was the creation of a site plan showing the parking layout for a regional hospital based on an aerial photo or map underlay. The aerial photo would first be inserted into a new AutoCAD drawing and then geometry added by tracing over this underlay. The resulting drawing shows the footprints of existing buildings, the extent of all on-site parking, and the individual parking spaces. Figure 3 shows the completed task #3 drawing.

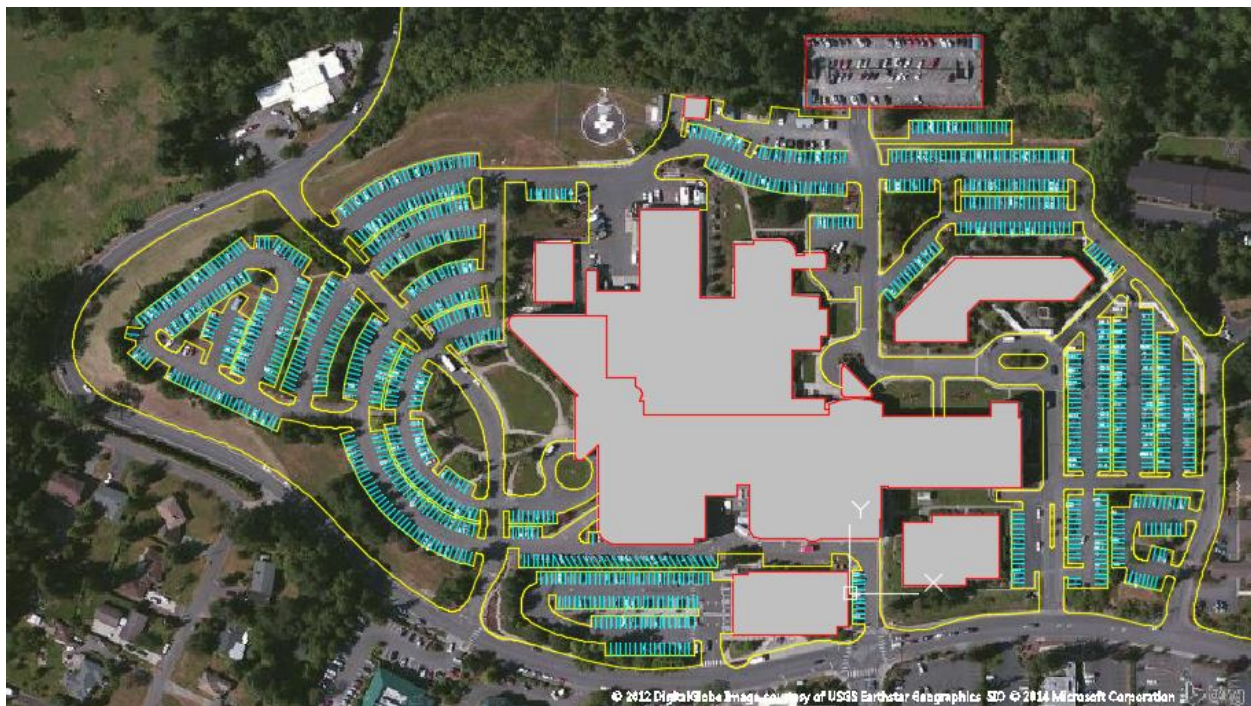

Figure 3: Completed task #3 drawing—a site plan/parking layout for a regional hospital.

In comparing AutoCAD 2010 to AutoCAD 2015, I had anticipated productivity improvements in a number of areas:

- The Geographic Location tools in AutoCAD 2015 would make it much faster and easier to add the aerial photograph to the AutoCAD drawing, versus having to first capture and import an image of an aerial photograph and then scale it appropriately in AutoCAD 2010.
- The ability to use associative path arrays would shorten the amount of time required to create parking layouts in AutoCAD 2015 versus having to use the Measure command with a block in order to lay out parking spaces in AutoCAD 2010.

This drawing took 2 hours: 20 minutes to complete using AutoCAD 2010 on the Dell Precision T1600 workstation. The same drawing took 2 hours: 2 minutes to complete using AutoCAD 2015 on the same workstation, a time

reduction of 13 percent. When the same drawing was created using AutoCAD 2015 on the Dell Precision T1700 workstation, the time required went down an additional 22 minutes, or 18 percent.

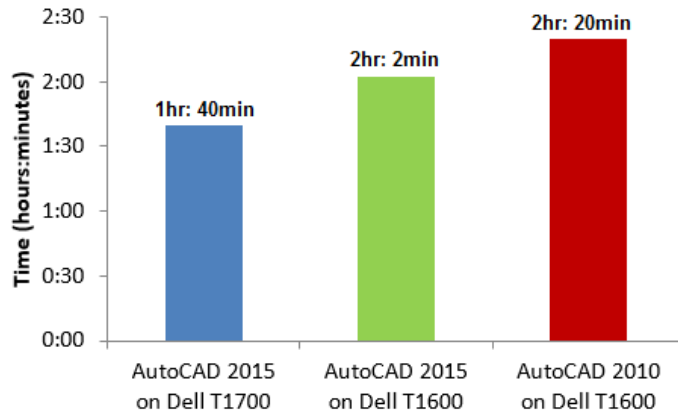

Task #3: A 2D site plan.

The Geographic Location tools in AutoCAD 2015 made it much easier to locate and position an aerial image of the project site in a new AutoCAD drawing. That image was also automatically scaled to match the drawing scale. When working in AutoCAD 2010, a similar aerial photograph had to first be captured from an online map service, saved as a bitmap image, inserted into a new AutoCAD drawing, and then scaled to match the drawing scale.

While the same methods were used in both AutoCAD 2010 and AutoCAD 2015 to draw the building footprints and the extents of the paving, the Path Array tool in AutoCAD 2015 proved to be a much faster way to create the individual parking spaces than the Measure tool in AutoCAD 2010.

When the improvement due to the upgraded workstation was factored in, the overall time required to complete this task improved by a total of 29 percent from AutoCAD 2010, largely due to the faster overall system performance and improved graphic performance of the newer workstation.

Drawing task #4

The fourth drawing task was the completion of a reflected ceiling plan for a rather complex office building. The floor plan of the office build was previously created. The task in this case was only to create the reflected ceiling plan. Portions of the floor plan were at odd angles, however, and one wing of the building curves. The ceiling tile pattern could be created as a user-defined hatch pattern but would need to be centered appropriately in each individual room as well as along a curving corridor. Blocks representing 24x48 light fixtures and round down lights as well as HVAC supply and return air diffusers and sprinklers would need to be added to the ceiling plan. Figure 4 shows the completed task #4 drawing.

Because of the new features available in AutoCAD 2015 compared to AutoCAD 2010, I had anticipated a number of productivity improvements. The most significant impact on the time required to complete this drawing would be in the addition of hatch patterns to represent the ceiling tiles in each room. In particular, I anticipated that being able to see and manipulate the angle of the hatch pattern and the origin of the pattern within each room would provide a significant reduction in the time required to complete this drawing in AutoCAD 2015 compared to AutoCAD 2010.

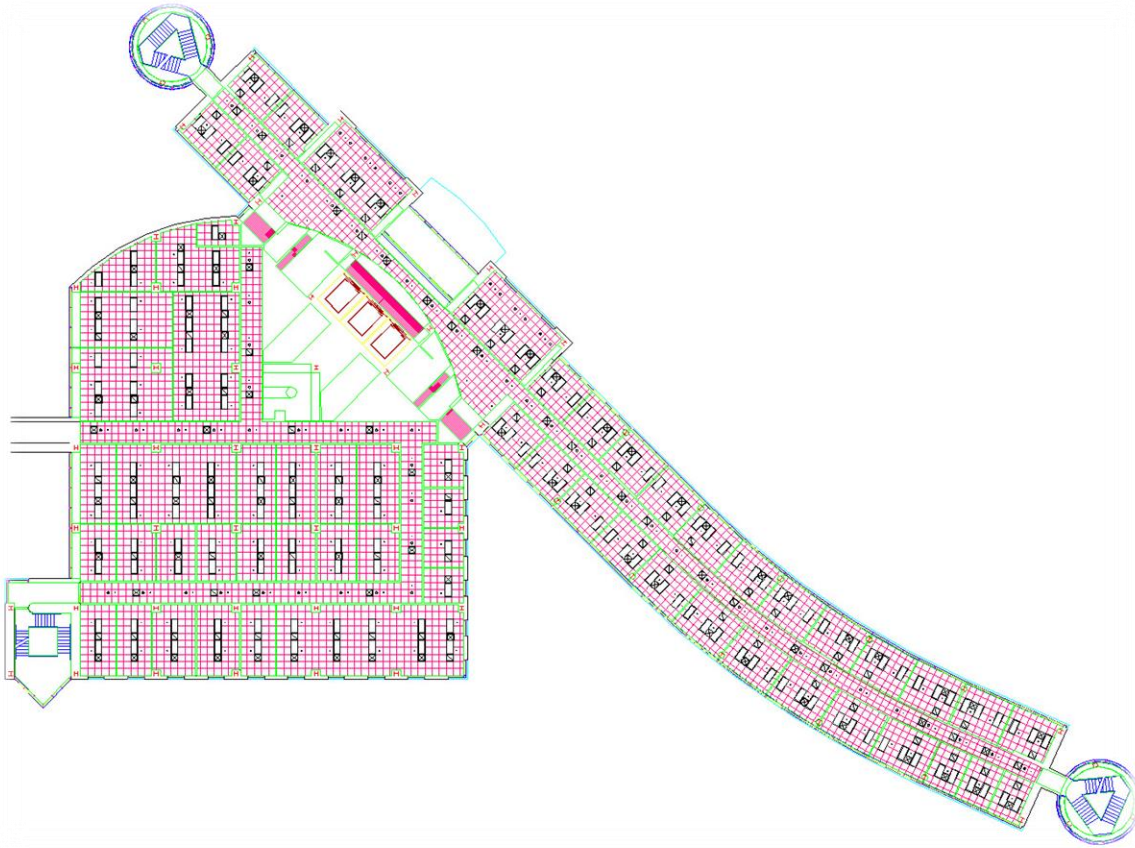
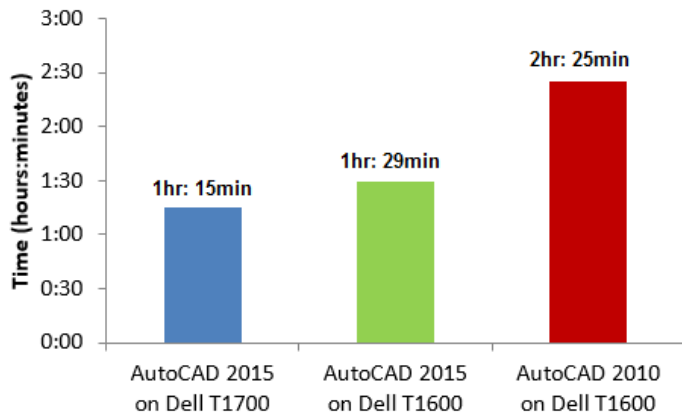

Figure 4: Completed task #4 drawing—a reflected ceiling plan of a complex office building.

This drawing took 2 hours: 25 minutes to complete using AutoCAD 2010 on the Dell Precision T1600 workstation. The same drawing took only 1 hour: 29 minutes to complete using AutoCAD 2015 on the same workstation, a time reduction of 39 percent. When the same drawing was created using AutoCAD 2015 on the Dell Precision T1700 workstation, the time required went down an additional 14 minutes, or 16 percent.



Task #4: Reflected ceiling plan of a complex office building.

AutoCAD 2015 was more efficient in the creation of the task #4 drawing than AutoCAD 2010. The most significant improvement was indeed both the ability to preview hatch patterns in AutoCAD 2015 and also the ability to use grip editing to quickly and easily modify the angle and origin of hatch patterns after they were added to the drawing. In AutoCAD 2010, it was much more difficult to get the ceiling tiles to align properly in each room, particularly those rooms along the curved portion of the building. When the improvement due to the upgraded Dell workstation was factored in, the overall time required to complete this task improved by a total of 48 percent from AutoCAD 2010, with the additional improvement largely due to improved processing speed and graphics performance when displaying and manipulating large areas of hatch.

Drawing task #5

The fifth drawing task was the creation of a three-dimensional model of a ceramic teapot. This task scenario was designed to highlight some of the improved surfacing, solid modeling, and rendering capabilities of AutoCAD 2015 compared to AutoCAD 2010. The three-dimensional model of the teapot was created by first creating two-dimensional curves and then using those curves to revolve the main body of the teapot. The spout was created by lofting interior and exterior profiles along a path. And the handle was created by sweeping a profile along a path. Boolean operations were then used to combine solids and subtract the hollow interior of the teapot and spout. A simple table was also created and materials were mapped onto the teapot, table, and floor. Lights were then added to the model, which was then rendered and saved as a bitmap image. Figure 5 shows the completed task #5 drawing.

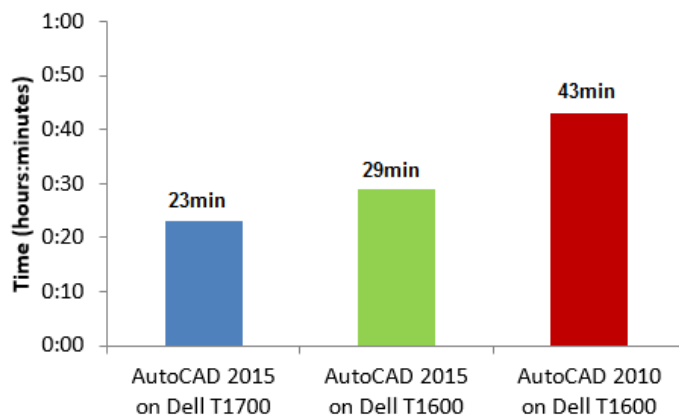

Figure 5: Completed task #5 drawing—a rendered image of a 3D teapot modeled using AutoCAD.

In comparing AutoCAD 2010 to AutoCAD 2015, I had anticipated productivity improvements in a number of areas:

- The ability to combine both solid and surface modeling in AutoCAD 2015 compared to using only solid modeling in AutoCAD 2010.
- The ability to hide and isolate individual curves and solids in AutoCAD 2015 versus having to control visibility entirely using layers in AutoCAD 2010.
- The improved material library in AutoCAD 2015 and the Materials Browser would make it easier to locate and apply materials compared to AutoCAD 2010.

This task took 43 minutes to complete using AutoCAD 2010 on the Dell Precision T1600 workstation, including the time required to apply materials, add lights, and render the scene. The same task took only 29 minutes to complete using AutoCAD 2015 on the same workstation, a time reduction of 33 percent. When the same task was performed using AutoCAD 2015 on the Dell Precision T1700 workstation, the time required went down an additional 6 minutes, or 21 percent.



Task #5: 3D conceptual design study.

The ability to combine both solid and surface modeling in AutoCAD 2015 made it much faster and easier to create the base curves on which the teapot was modeled compared to working solely with solids in AutoCAD 2010. It was also much faster to simply hide individual curves and solids in AutoCAD 2015 using object isolation compared to having to create each curve or solid on its own layer in AutoCAD 2010. In AutoCAD 2010, a custom material had to be created to represent the glazed ceramic finish of the teapot whereas the AutoCAD 2015 material library included a stock material that could be used for this purpose.

When the improvements due to the upgraded workstation was factored in, the overall time required to complete this task improved by a total of 47 percent from AutoCAD 2010, largely due to the improved rendering time afforded by the faster CPU in the newer workstation.

Since this task also included rendering as a final step, it is also worth mentioning that I could have saved additional time by using the cloud-based rendering capability available in AutoCAD 2015. When rendering on the local computer, AutoCAD is unavailable for other tasks until the rendering is complete, a process that took anywhere from just over 5 minutes to nearly 10 minutes for this task. When using AutoCAD 2010, I had no choice but to wait until the rendering was completed. But had I used cloud based rendering in AutoCAD 2015, I could have performed other tasks in AutoCAD while waiting for the rendering to be completed online.

About the systems used for testing

The five task drawing scenarios were completed on the same computer platform, using both AutoCAD 2010 (suggested retail price of \$3,995 when first introduced) and AutoCAD 2015 (suggested retail price of \$4,195 as of the testing date):

- A Dell Precision T1600 workstation equipped with a 3.2GHz Intel Core i5-3470 quad-core CPU, 8GB of RAM, an NVIDIA Quadro 2000 graphics board, and a 500GB 7200rpm hard drive. This system had a suggested retail price of \$2,325 when it was first introduced.

The AutoCAD 2015 tests were then repeated on a more modern computer platform:

- A Dell Precision T1700 workstation equipped with a 3.1GHz Intel Xeon E3-1220 quad-core CPU, 16GB of RAM, an NVIDIA Quadro K2000 graphics board, and both a 500GB SSD and a 256GB SSD. This system has a suggested retail price of \$2,557 as of this testing date.



Figure 6: The tests were repeated on a Dell Precision T1700 workstation.

In every test scenario, the time required to complete the drawing was reduced when AutoCAD 2015 was run on the newer platform compared to AutoCAD 2010 on the older workstation. Those times are summarized in the following table.

	AutoCAD 2010 on Dell T1600	AutoCAD 2015 on Dell T1600	AutoCAD 2015 on Dell T1700	Time reduction ACAD2010 to ACAD2015 (on Dell T1600)	Time reduction ACAD2010 on Dell T1600 to ACAD2015 on Dell T1700
Task 1	2 hr: 28 min	1 hr: 30 min	1 hr: 16 min	39%	49%
Task 2	2 hr: 15 min	1 hr: 3 min	0 hr: 45 min	53%	67%
Task 3	2 hr: 20 min	2 hr: 2 min	1 hr: 40 min	13%	29%
Task 4	2 hr: 25 min	1 hr: 29 min	1 hr: 15 min	39%	48%
Task 5	43 minutes	29 minutes	23 minutes	33%	47%
TOTAL	10 hr: 11 min	6 hr: 33 min	5 hr: 19 min	36%	48%

I recorded these time savings in spite of the fact that all of the task scenarios (with the exception of task #5) consist of drawing and editing typical AutoCAD models rather than compute-bound operations such as rendering or analysis. (For task #5, a finished rendering was included as part of the process.) The reduction in the time required to complete the same tasks when running AutoCAD 2015 on the newer workstation compared to the older workstation is likely the result of several factors:

- The faster CPU and NVIDIA graphics accelerator likely resulted in faster manipulation of both three-dimensional models and two-dimensional graphics. This enabled the user to pan, zoom, and orbit more quickly. Over a typical work session, this can save a considerable amount of time.
- AutoCAD 2015 seemed more responsive on the Dell Precision T1700 workstation than AutoCAD 2010 on the Dell Precision T1600.
- The improved graphics used in AutoCAD 2015 takes advantage of advanced capabilities of the NVIDIA graphics card, whereas the native video driver in AutoCAD 2010 does not.
- For task #5, the improved performance was also due to the faster CPU, which enabled a reduction in rendering time.

Productivity improvement

For each of the five task scenarios, I measured the time required to complete the drawings using the two different workstation configurations. The results in the report are then explained in terms of the amount of time saved as a result of:

- Upgrading from AutoCAD 2010 to AutoCAD 2015 while continuing to run the software on the same Dell Precision T1600 workstation.
- Additionally upgrading to a Dell Precision T1700 workstation.

In addition to looking at the results in terms of the time savings, they can also be expressed in terms of productivity or measured output. A reduction of 20 percent in the amount of time required to complete a task equals a 25 percent improvement in user output.

$$\text{Percent time saved ACAD2010 to ACAD 2015} = \frac{\text{ACAD 2010 time} - \text{ACAD 2015 time}}{\text{ACAD2010 time}}$$

$$\text{Productivity improvement ACAD2010 to ACAD2015} = \frac{\text{ACAD2010 time} - \text{ACAD2015 time}}{\text{ACAD2015 time}}$$

For example, on task #2, the time required to complete the drawing decreased from 2 hours: 15 minutes using AutoCAD 2010 to 1 hour: 3 minutes using AutoCAD 2015, a reduction of 53 percent. Using the formula above, that represents a productivity improvement when using AutoCAD 2015 of 114 percent, or better than 2 times the output compared to AutoCAD 2010. The respective productivity improvements are summarized in the following table.

	AutoCAD 2010 on Dell T1600	AutoCAD 2015 on Dell T1600	AutoCAD 2015 on Dell T1700	Productivity improvement ACAD2010 to ACAD2015 (on Dell T1600)	Productivity improvement ACAD2010 on Dell T1600 to ACAD2015 on Dell T1700
Task 1	2 hr: 28 min	1 hr: 30 min	1 hr: 16 min	64%	95%
Task 2	2 hr: 15 min	1 hr: 3 min	0 hr: 45 min	114%	200%
Task 3	2 hr: 20 min	2 hr: 2 min	1 hr: 40 min	15%	40%
Task 4	2 hr: 25 min	1 hr: 29 min	1 hr: 15 min	63%	93%
Task 5	43 minutes	29 minutes	23 minutes	48%	87%
TOTAL	10 hr: 11 min	6 hr: 33 min	5 hr: 19 min	55%	92%

Therefore, when expressed as productivity improvement, the test results show that users can improve their current output by 55 percent (or 1.55 times) as a result of upgrading from AutoCAD 2010 to AutoCAD 2015 without any change in the computer on which AutoCAD is run. When they also invest in a new workstation with a more modern graphics accelerator, they can achieve a productivity improvement of 92 percent or 1.92 times their current output.

Benchmark results

In addition to the user productivity analysis performed using the five drawing task scenarios, I also performed more traditional quantitative analyses of the computer hardware using a number of different benchmarks, including the SPEC viewperf benchmark to measure 3D graphics performance and the CADalyst benchmark to measure various aspects of system performance when running AutoCAD.

These benchmarks are synthetic tests that generally yield a single number or series of numbers that show the relative performance of the entire computer or a particular subsystem (such as the graphics accelerator or hard drive). While the resulting numbers can be compared to see which system or subsystem is faster, these types of tests do not provide significant insight into actual user productivity. That said, they do provide an additional metric for measuring the relative performance of the workstations used in this productivity study.

I performed a total of six different benchmark tests:

- The CADalyst benchmark
- SPEC viewperf
- An AutoCAD rendering benchmark
- An AutoCAD script to measure performance when working with very large drawing files
- A test to determine system boot time
- A test to determine AutoCAD load time

CADalyst benchmark

The CADalyst benchmark is designed to test and compare the performance of systems running AutoCAD. The benchmark compares the test times of the system with a set of base times, and computes an index number. An index score of 135, for example, means that the system being tested is 135 times faster than the base system for the functions tested. The Total index score is calculated based on sub-index scores for four areas of performance: 3D graphics, 2D graphics, disk, and CPU.

This benchmark was originally developed by Art Liddle, the former technical editor of *CADalyst* magazine. I used the latest version of the benchmark, which is compatible with AutoCAD 2015. On the Dell Precision T1600 workstation, I ran the test using both AutoCAD 2010 and AutoCAD 2015. On the Dell Precision T1700, I tested using AutoCAD 2015 only.

AutoCAD 2015 is more demanding of the computer hardware than AutoCAD 2010. As a result, the CADalyst benchmark results for AutoCAD 2015 were lower than those for AutoCAD 2010 when both tests were run on the Dell T1600. But most of the results were significantly higher for AutoCAD 2015 running on the Dell Precision T1700 workstation. The Total CADalyst benchmark index improved 16 percent going from AutoCAD 2010 on the Dell T1600 to AutoCAD 2015 on the Dell T1700. It was 28 percent better when comparing AutoCAD 2015 on each system.

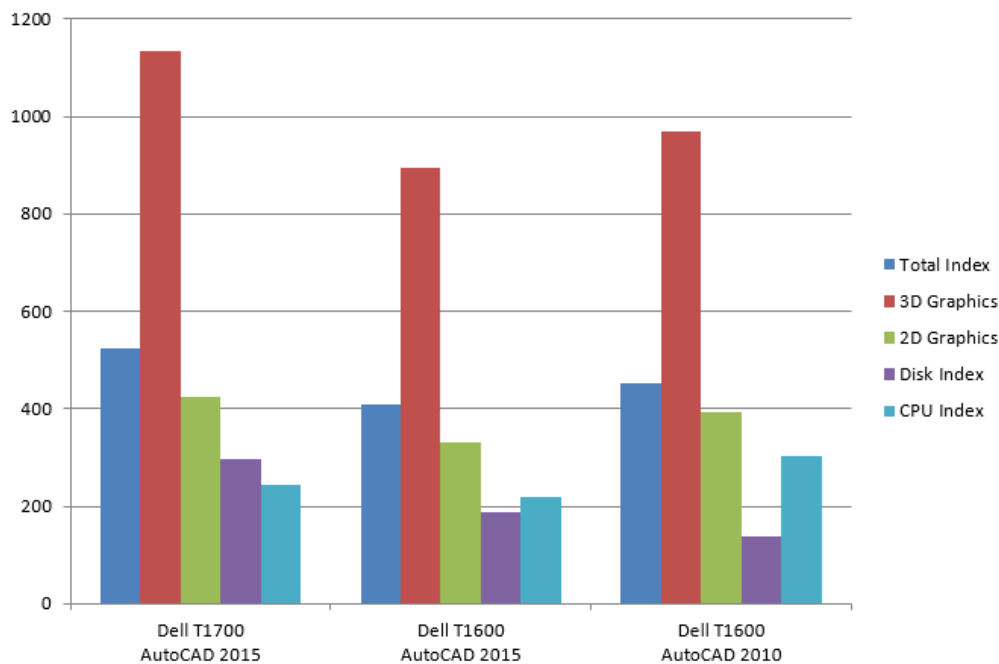

CADalyst benchmark results.

Due to the many improvements in AutoCAD over time, running a newer version on older hardware actually results in a decrease in software performance. Based on my results, it appears clear that when upgrading from a significantly older version of AutoCAD to the latest release (such as from AutoCAD 2010 to AutoCAD 2015), one should also upgrade to a new workstation. The improvement in performance and productivity justifies the investment.

SPEC viewperf

The SPEC viewperf benchmark measures the 3D rendering performance of systems running under OpenGL. The benchmark renders a series of large datasets created in eight different CAD and DCC (digital content creation) programs, recording the number of frames displayed per second. Each viewset represents the rendering portion of the actual application. The benchmark then reports its results as the weighted geometric mean as the single composite metric for each viewset. This benchmark tests only the graphics performance, and is truly a synthetic metric rather than a measure of actual application performance. That said, it does provide a useful comparison of the relative performance of different workstations and graphic card combinations. I also included it among the benchmark tests I performed due to its extensive use throughout the industry.

There have been numerous versions of the SPECviewperf benchmark. I tested using both Viewperf version 11 and version 12. Both versions of the benchmark can be run at various resolutions and as both a single-threaded test and in several multi-threaded variations. I performed my tests at a resolution of 1280x1024 as a single thread.

As expected, the results improved significantly when upgrading from the Dell Precision T1600 with an NVIDIA Quadro 2000 graphics board to the newer Dell Precision T1700 equipped with a newer NVIDIA Quadro K2000 GPU.

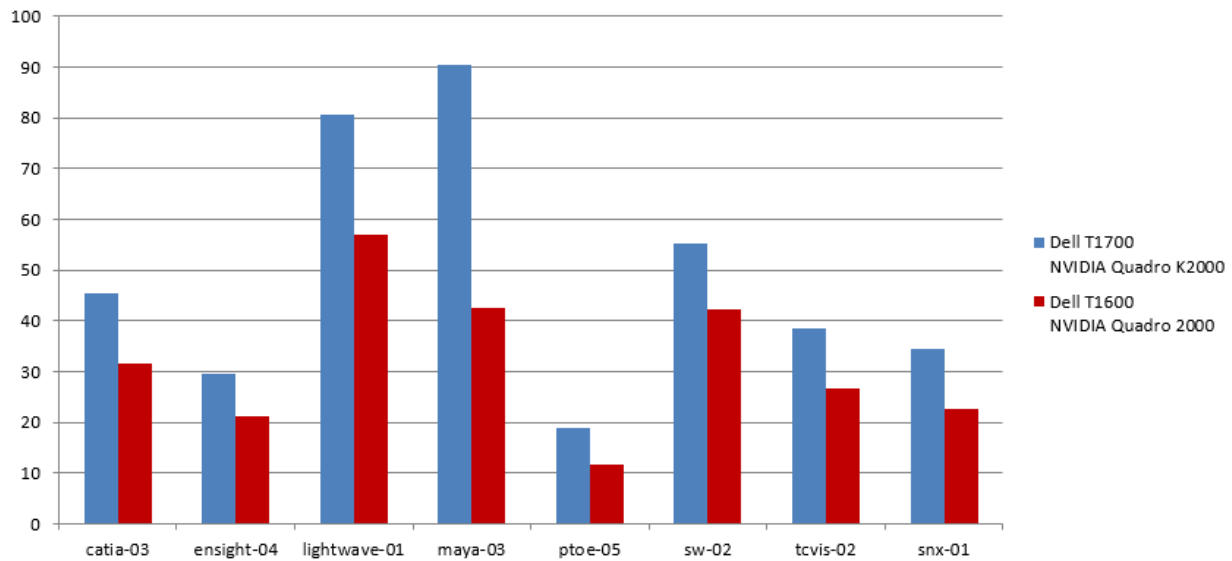

SPEC viewperf 10 benchmark results.

Depending on the viewset, the SPEC viewperf results improved anywhere from 31 to 112 percent, with the newer Dell Precision T1700 performing on average 53 percent better than the older Dell T1600.

AutoCAD rendering benchmark

The AutoCAD rendering benchmark consists of a sample 3D drawing of a single-family house. This drawing file was originally provided by Autodesk. A script file is used to render a previously saved interior view of the house multiple times at “presentation” quality at an output size of 1280x1024. The mental ray® rendering engine in AutoCAD automatically records the time required to render each image. The result reported is the average time required to create each rendered image.

Since the mental ray rendering engine used in AutoCAD is multi-threaded, this test is an excellent indication of the advantage of using multiple CPUs and multi-core CPUs; the more cores available, the faster the performance, with the differential being almost linear. This test has been used extensively for several years as part of a suite of benchmarks performed when evaluating all computer systems for reviews published in *Desktop Engineering* magazine, so historical performance results for other systems are also available. This is a very valuable benchmark for anyone who intends to produce rendered images from 3D AutoCAD models.

As expected, the Dell Precision T1700 was able to complete the rendering much faster than the Dell Precision T1600—1 minute: 14.5 seconds versus 1 minute: 39.8 seconds—an improvement of 34 percent. On the Dell T1600, the rendering took longer (1 minute: 50.2 seconds) to complete when running AutoCAD 2015.

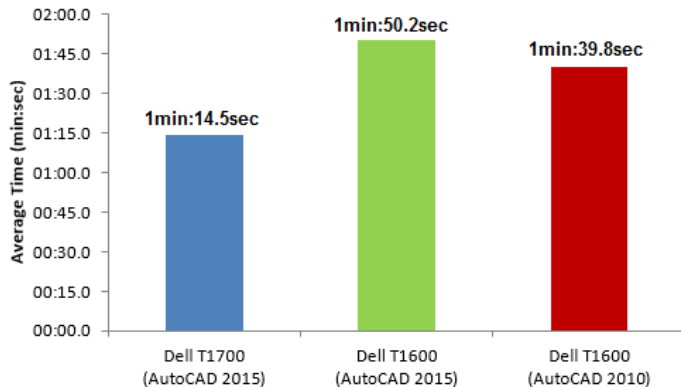

AutoCAD rendering benchmark results.

AutoCAD large drawing benchmark

This benchmark is meant to gauge the performance of the workstation running AutoCAD when working on large models. The test records the time it takes to load a large AutoCAD drawing file (28 MB) provided by an actual AutoCAD customer, and then performs numerous pans, zooms, and viewpoint changes as well as changes in the visual style used to display the model, all drawing manipulations that a typical user would perform during the course of his or her work, yet tasks that are quite time consuming when working with large models. Unlike many of the other benchmarks, this test provides data that can serve as an indicator of actual user productivity.

As expected, AutoCAD 2015 outperformed AutoCAD 2010 on this test. It took 2 minutes: 54 seconds to complete this test on the Dell Precision T1600 running AutoCAD 2010 compared to 1 minutes: 35 seconds on the same system running AutoCAD 2015, a performance improvement of 83 percent. When I ran the same test on the Dell Precision T1700 running AutoCAD 2015, the time required to complete the test dropped to 1 minute: 17 seconds, an additional 23 percent improvement over the Dell T1700 running the same version of AutoCAD 2015 and a 126 percent improvement compared to the Dell T1600 running AutoCAD 2010.

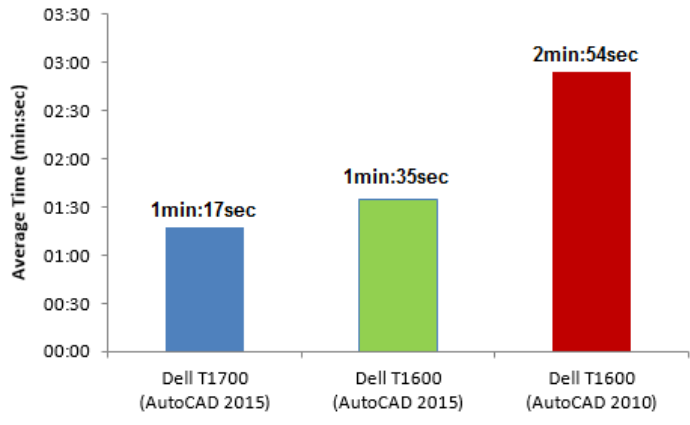

AutoCAD large drawing benchmark results.

Basic computer operations

The time required for Dell Precision T1700 to boot up was considerably shorter than for the Dell Precision T1600. The Dell T1600 workstation was ready to start programs approximately 59 seconds after pressing the power button. The Dell Precision T1700 was ready to start programs approximately 22 seconds after power-up, 45 percent faster.

The time required to load the AutoCAD was nearly the same on both workstations regardless of the version. AutoCAD 2010 took 10 seconds to load on the Dell T1600. AutoCAD 2015 was ready to use approximately 9 seconds after loading on both the Dell T1600 and T1700 workstations. Once AutoCAD was up and running on the respective systems, however, AutoCAD 2015 seemed more responsive on the Dell Precision T1700 than on the T1600.

Conclusions

The results of this productivity study were both dramatic and conclusive—AutoCAD 2015 is significantly more productive than AutoCAD 2010. What's more, upgrading one's workstation as well as upgrading from AutoCAD 2010 to AutoCAD 2015 results in an average overall productivity improvement of more than 90 percent.

When creating typical drawings, the use of new features and functionality introduced since AutoCAD 2010 result in time savings ranging from 13 to 53 percent, with an average time savings of 36 percent. This equates to individual productivity gains ranging from 15 to 114 percent, with an average overall productivity improvement of 92 percent.

Upgrading one's workstation as well as upgrading from AutoCAD 2010 to AutoCAD 2015 results in time savings ranging from 29 to 67 percent, with an average time savings of 48 percent. This equates to individual productivity gains ranging from 40 to 200 percent, with an average overall productivity improvement of 92 percent.

While different individuals will likely experience varying degrees of improvement, depending on the nature and complexity of the drawings and their skill levels, similar levels of improvement are highly likely. Enhancements to the AutoCAD user interface so yields a more satisfying user experience.

Most users will be able to get more work done faster as a result of moving from AutoCAD 2010 to AutoCAD 2015. The amount of improvement likely to be recognized is so significant that most users will conclude that it easily justifies the cost of upgrading.

The additional improvement in user productivity resulting from also upgrading the computer workstation and graphics card is also so significant that most users should recognize a very fast return on their investment, easily justifying the cost of upgrading their hardware as well as their AutoCAD software.



About the Author

David Cohn is the Technical Publishing Manager at 4D Technologies, where he develops the CADLearning® courses and eBooks for AutoCAD and other Autodesk products. He has more than 30 years of hands-on experience with AutoCAD as a user, developer, author and consultant. He has been benchmarking computer hardware and software since 1985 and has published hundreds of articles and reviews as a contributing editor to *Desktop Engineering* magazine, the former publisher and editor-in-chief of *CADCAMNet* and *Engineering Automation Report*, and the former senior editor of *CADalyst* magazine. He is also the author of more than a dozen books about AutoCAD. A licensed architect, David was also one of the earliest AutoCAD third-party software developers, creating numerous AutoCAD add-on programs. He has also taught college-level AutoCAD courses and is always a popular presenter at Autodesk University.



This productivity study was performed at the request of Autodesk and Dell, which funded this work.



Autodesk, Inc.
111 McInnis Parkway
San Rafael, CA 94903



Dell Inc.
One Dell Way
Round Rock, TX 78682



David S. Cohn Consulting
711 Chuckanut Drive North
Bellingham, WA 98229-6921

Phone: 360-733-0711
Web: www.dscohn.com

The analysis and opinions in this report reflect my best judgment as of writing but are subject to change without notice. David S. Cohn shall not be liable for any loss or injury resulting from the use of this information. All trademarks and copyrights to products mentioned or images used are the property of their respective owners. Screen images courtesy of Autodesk.

Autodesk, AutoCAD, Autodesk Inventor, the Autodesk logo, AUGI, and Inventor are registered trademarks or trademarks of Autodesk, Inc., and/or its subsidiaries and/or affiliates in the USA and/or other countries. mental ray is a registered trademark of NVIDIA ARC GmbH, licensed for use by Autodesk, Inc. All other brand names, product names, or trademarks belong to their respective holders. Autodesk reserves the right to alter product and services offerings, and specifications and pricing at any time without notice, and is not responsible for typographical or graphical errors that may appear in this document. © 2014 Autodesk, Inc. All rights reserved.